



SAIC MAXUS Automotive Co., Ltd.

Tel: +86 21 6056 9999 Zip: 200438

Fax: +86 21 6056 9000

Address: No.2500 Jungong Rd., Yangpu District, Shanghai, P.R.China

This manual was printed in April 2019. Pictures and product information are only for your reference. Product specification should be subject to the real vehicle.
SAIC MAXUS Automotive Co., Ltd has the final and exclusive right to explain this manual.

» SAIC Motor

SAIC Motor Corporation Limited (SAIC Motor) is the largest auto company on China's A-share market (Stock Code: 600104), and has a total equity of 11.683 billion shares. SAIC Motor strives to grasp the trend of industrial development and speeds up the innovation-driven industrial transformation, and it is growing into a full-range vehicle products and travel services provider from a traditional manufacturing enterprises.

SAIC Motor's car sales hit 7.05 million units in 2018, up 1.75 percent on the previous year and keeping its leading market share in China. In 2017, the company climbed 5 places to rank 36th on the annual Fortune Global 500 list, thanks to its \$128.819 billion in revenues. It marked the 14th time that the company had made it onto the list of Fortune magazine's 2017 Global 500.

» SAIC MAXUS Automotive Co., Ltd

SAIC MAXUS Automotive Co., Ltd (hereinafter as "SAIC MAXUS") is a wholly-owned subsidiary of SAIC Motor Corporation Limited. Established on 21st March, 2011, its headquarters is located at No. 2500 Jungong Road with a registered capital of 5.82 billion RMB.

Subsidiaries of SAIC MAXUS include Wuxi Branch, Nanjing Branch, Shanghai Lingang Branch, SAIC MAXUS Motor Home Science & Technology Co., Ltd, Wuxi Shenlian Special Purpose Vehicle Co., Ltd, SAIC MAXUS Sales and Services Co., Ltd. It also has two intelligent R&D centers, two overseas manufacturing bases and four domestic intelligent manufacturing bases.

Currently, main business of SAIC MAXUS includes products matrix featuring MPV, SUV, wide-bodied light passenger vehicle, pick-up, intelligent RV and passenger and other passenger and commercial vehicles, as well as R&D, production and sales of various special purpose vehicles. It is actively promoting commercialization of new energy vehicle and car on the Internet, conducting technological research on intelligent driving and exploring industrialization.

As an international brand of SAIC Motor, SAIC MAXUS has maintained its fast growing momentum in sales. SAIC MAXUS is honored to have served APEC, G20, SCO Summit, the Youth Olympics, Boao Forum for Asia, BRICS International and other high-level international conferences with its state-guest-level quality. In terms of overseas market, global products of SAIC MAXUS cover 46 countries and regions in the world. With Australia, New Zealand, UK, Ireland and other developed countries contributing most to overseas sales, SAIC MAXUS is becoming a Chinese brand marching towards the world.

Adhering to its core brand value of "Technology, Trust, Ambition", SAIC MAXUS was the first to initiated the C2B business model in the automobile industry which allows real-time, online and transparent interaction with users along the entire value chain and customized production as well as intelligent manufacturing. Through business model and commercial model innovation, SAIC MAXUS dedicates to be a vehicle brand "driven by users, providing automobile products and lifestyle service with global competitiveness and creating value for users."



**Showcase brand image and
go with the future**

**Rooted in the world stage and
achieve global network**

Heritage with a history of 120 years

Time is the catalyst for qualitative leaps

Profound accumulation leads to new life

More than 100 years ago, the birth of the LDV model in Britain was the legendary origin that SAIC MAXUS can trace back.



1949 Morris J launched



1989-1993 200 Series Leyland DAF



1984-1989 300 Series Wide-body version of Freight Rover 200 family



1993 A new start LDV Limited formally established.



2009 Great birth SAIC Motor fully acquired Maxus brand of LDV company, the legendary "SAIC MAXUS" came on stage!

2012 SAIC MAXUS officially launched alight-duty truck V80 to meet the needs of many commercial vehicle owners and obtained their favor.



2014 SAIC MAXUS brand strategy, all-field MPV G10 launched.



2016 SAIC MAXUS launched T60 pickup on Guangzhou Auto Show. The launch of SAIC MAXUS RV80.



2017 SAIC Maxus SUV D90 Launch

SAIC Maxus G10 PLUS Launch Intelligent MPV



2018 SAIC Maxus V80 Overall Upgrad



SAIC Maxus RG10 Launch

SAIC MAXUS – The Legendary International Brand of Commercial Vehicle 1896 Legendary origin

As one of Europe's most powerful commercial vehicle brands, MAXUS not only accumulates a century-old development experience of commercial vehicles and strong technologies, but also leads international commercial vehicle market with its constant efforts of innovative expansion. It is now being seen all over the world and is known as a legendary International brand of commercial vehicle.

In 2009, SAIC Motor, the world's Fortune 500 enterprise, made a full acquisition of British Motor Corporation's technology platform and intellectual property rights of MAXUS brand. MAXUS was introduced into China and named as "Da Tong" in Chinese. This initiative not only set a new milestone in the development of commercial vehicles in China, but also ushered a brilliant new chapter of the legendary brand MAXUS.

1907 High-speed development The fast-growing company Lancashire was reorganized into Leyland Motor Company.



1917 Royal favor

The Windsor Dynasty began to govern England, and the successor models of Leyland joined the royal family fleet.

1974-1982 Sherpa, Leyland



1989-1993 400 Series Leyland DAF

Because of Dutch DAF commercial vehicle's joining, the Freight Rover became Leyland DAF.



1989-1993 400 Series Leyland DAF

1987 Turn again

1990

2004 A star was born

LDV Company created a new commercial vehicle named Maxus (prototype of SAIC MAXUS V80) and it became a superstar in the history of commercial vehicles.



2004-2009 Maxus LDV

2011 Legend continued



SAIC launched MAXUS V80 which made a comprehensive upgrade while maintaining the basic style of the original LDV Maxus.

2014 Spread both wings and march with the future



SAIC MAXUS EV80 First pure electric wide-body light passenger vehicle launched in China.



2015 SAIC MAXUS first automatic wide-body light passenger vehicle launched in China.

2016 Innovation Drives Diversified Future



The launch of SAIC MAXUS first pure electric MPV EGI0 domestically.



The launch of SAIC MAXUS FCV80 hydrogen fuel cell powered vehicle.

2017

2018



SAIC Maxus G50 Launch

Core Value of Big Brand

Inject more vitality into our cause
Driving greater motivation for your dreams



MAXUS Logo setting industry benchmark



- Gathering brand value, Technology•Trust•Ambition
- Showcasing brand image and go with the future
- Rooted in world stage and achieve global network

Three brand core values

Driven by **technology-driven** and marching with the future of the industry

A close-up image showing a human hand reaching out from the right, with the index finger pointing towards a metallic, articulated robotic hand on the left. A bright, glowing light emanates from the point where the two hands are nearly touching, symbolizing technology and human interaction.

Based on **trust** and marching with the future of consumers

A group of people in skydiving gear are shown in a circular formation, falling through the sky. The background is a clear blue sky, and the skydivers are in various poses, suggesting a sense of freedom and shared experience.

Guided by **ambition** and marching with the future of the era

A person is surfing on a large, powerful wave. The surfer is positioned on a yellow surfboard, riding the crest of the wave. The water is a vibrant blue, and the sky is clear, conveying a sense of adventure and achievement.

International First-class Standard

Change a lifestyle

Seven No.1 in its kind

- The most spacious 3rd row space of its kind
- The widest space in 2nd & 3rd row for knee of its kind
- The longest side airbag curtain fully covered the 3rd row in its kind
- The optimal passive safety of its kind
- The most powerful 4WD system in its kind
- The biggest 12.3 inch HD touch screen in its kind
- The strongest thermoforming pillar of its kind

Seven leading configurations in its kind

- Leading intelligent driving assistant system in its kind
- Advanced intelligent parking assistant system in its kind.
- Leading active-passive safety system in its kind.
- Leading high-efficient power train in its kind.
- Advanced all-terrain intelligent driving system in its kind
- Leading easy-entry from both sides function in its kind
- Superior driving and riding experience in its kind





Full-size intelligent customized Internet SUV

You, why need a car?

To make you travel further or to bring you greater heart?

SAIC MAXUS D90, thinking of you, starting from your heart.

With a wide space, serve the
collective needs of every family member.

With customization, provide exclusive services.

Intelligent connection brings the world into vehicle.

A high-powered SUV, let you just look into the distance without
worrying about the beneath, following your heart.

Intelligent customized Internet SUV

Not to define SAIC MAXUS D90

But to redefine your life.

Inspired by the application of "deconstruction" in architecture, The automotive design of SAIC MAXUS D90 presents: Break-to change continuity or completeness, Reorganization-to meet functional reconstruction, Constant change-the static display of movements, To break the inherent layout; SAIC MAXUS D90 carefully carved for equarters, Not only sporty ,but also ensures the head space of the third row.Makes a strong car body without losing its layers, and the distinguished lines look more smooth.



Innovative design, leading on the road



>> Integrated suspended roof line design

Use the laser welding technology of "zero clearance with roof cover" combined with high quality laser brazing, a surface welding technology and the welding length reached 5,000mm. Strengthen welding technology and make welding seam more delicate.



>> Streamlining luggage rack unified with roof

The 1.9-metre-long 3D full aluminum top luggage rack meets the machining accuracy requirements of the aircraft. It hides attachments and well integrates function and decoration.



>> Striking LED hi-tech headlights

Sharp eyes make the car head look more sporty with pure light color, farther irradiation distance, low power and heat, energy saving and environmental protection and long service life. The response speed can reach nanoscale and light up without delay.



>> G-shape LED taillights with thick walls

Highly recognizable taillights, beautiful, clear and the car behind can easily identify the model.

The interior adopts the concept of "parametric design",
 Recreates the wonders of nature with modern craftsmanship and technology:
 Horizontally flattening IP dashboard design,
 Transverse surrounded doors with extension layout
 With panoramic sunroof and integrated cockpit,
 The interior design is full of rhythm of art,
 Stereo layered design with both forms and functions
 Combined with panoramic sunroof,
 Not only allows the interior to stretch smoothly,
 But also has low noise design and 64-color mood lighting
 Provides a "broad" vision and comfortable driving experience.



Ingenious Interior Opens Your Heart



>> Inner Cabin Design

Horizontally flattening IP dashboard design highlights the horizontal open feeling; The IP dashboard and doors stretch horizontally and encircle; Stereo layered design has both forms and functions.



>> Elaborate interior detail

The parametric design of interior and other details are carefully crafted and the detail processing can reflect the meticulous and rigorous vehicle production.



>> Multifunctional steering wheel with sportive flat bottom

Leather wrapped, best hand feeling, classic design with four ways, well-organized control characteristics, four-direction adjustment to meet the needs of different figures, selection of steering wheel heating to greatly increase winter operating comfort.



>> Embracing an integrated cockpit

Greater space, better vision, more comfortable driving experience.



>> Comfortable leather seats with diamond-shape patterns

Luxury diamond-shape pattern and French double seam are widely used in SAIC MAXUS D90 with exquisite workmanship, bringing comfortable experiences.



>> Horizontally flattening IP dashboard design

Save more space and provide a more comfortable experience



Live wisely

Live for the future, live wisely

Wisdom, is the way of life, but also today's way of driving;

Wisdom, is interacting with all things without moving;

With the wisdom to achieve self-worth,

Also believe that life is the process of linkage with the world;

Seat in the car but connect with all things,

Hold internal and external information in the palm.

Live for the future, live wisely

New generation ADAS

Through Mobileye advanced visual camera, transmit traffic information captured in real-time to central data brain, After analysis, send instructions to each control module within the car body in order to control the vehicle, achieve L2-level of automatic driving and make the journey more relaxed and comfortable.

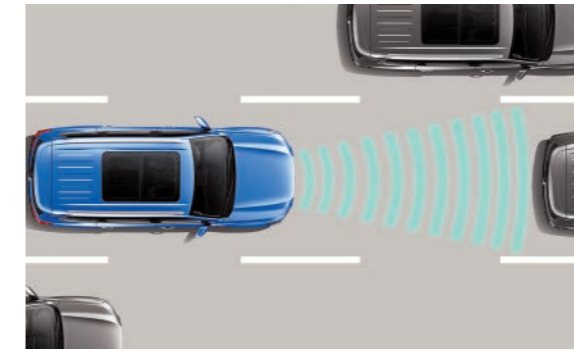
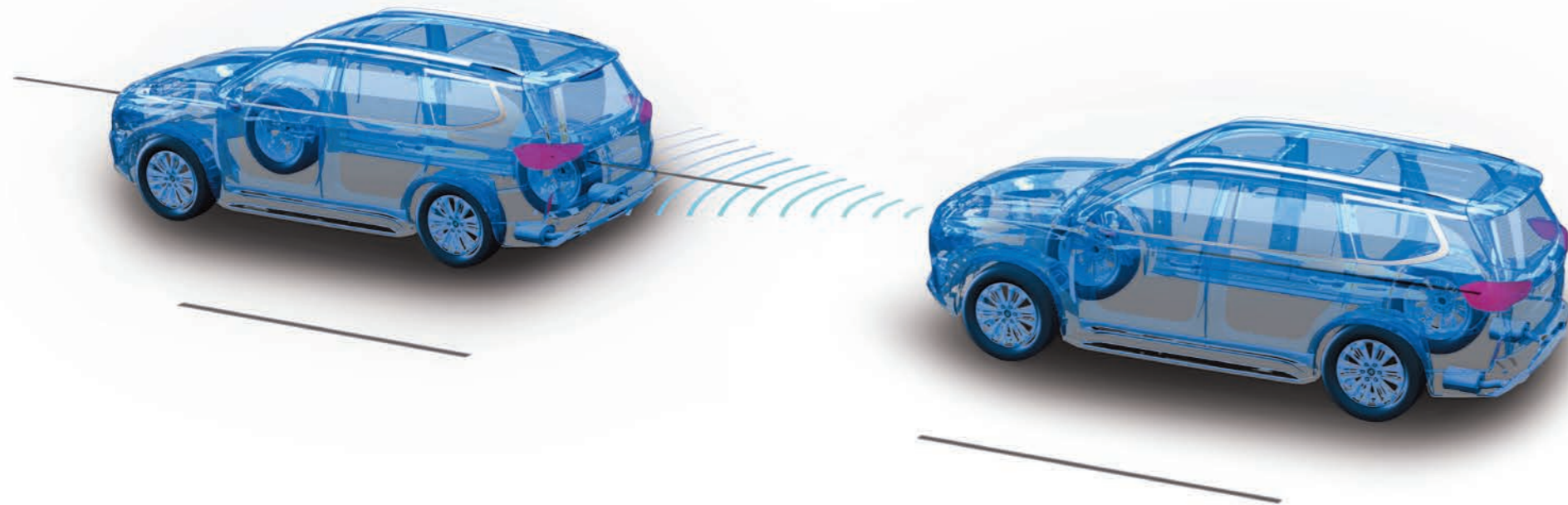

>> ACC(Adaptive Cruise Control)

0-150km/h automatic cruising function is realized through intelligent gas and brake control.Easily coping with cars followed while waiting for red light or in traffic jam.Free your feet with continuous use of this function.

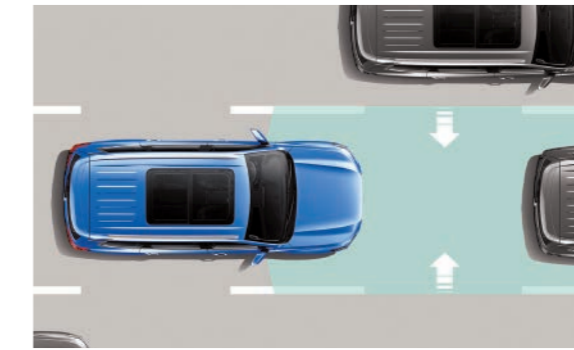

>> LKA (Lane-Keeping Assist)

The system takes over the steering wheel, allowing the vehicle to automatically drive in the lane line, thus freeing your hands.

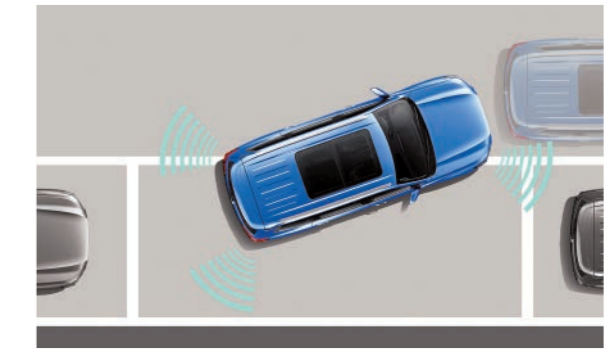

>> APA (Automatic Parking Assist)

The ultrasonic sensor scans and judges the storage space and the wheel speed sensor locates the vehicle space position.The driver simply hangs in the R file and controls the brake pedal to complete the parking.

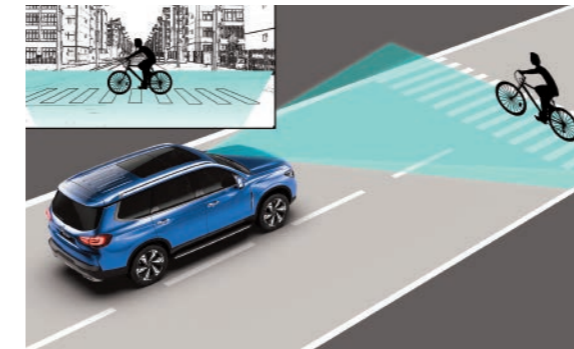

>> Mobileye high-sensitivity camera with machine vision

Developed by a research company with world's most advanced vision algorithm and driving aid system chip technology,its recognition ability is superior to human eyes and can master deep intelligent learning.

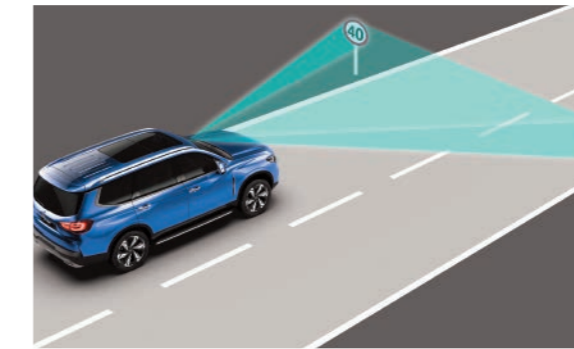

>> TSR traffic sign recognition

The camera can recognize speed limit, no overtaking and other road signs, and display the content on the dashboard, reminding drivers to notice.



>> PDS pedestrian detection system

Machine vision is superior to human eyes and can identify people, children, cars, cyclists (need obvious features of a person), then transmits information to the computer for analysis and judgment in order to give other system instructions.

Travel over a long and trying journey Come back safe and sound

>> Double five-star safety standards



C-NCAP 5-star collision standards
A-NCAP 5-star collision standards

>> Exceeding Rich Intelligent and Active Security

- FCW front intelligent collision warning system
- AEB automatic emergency brake
- LDW lane departure warning
- Fatigue detection
- BSD blind-spot monitoring system
- Bosch's newest generation of ESP (Electronic Stability Program)
- RMI active rollover protection
- TPMS intelligent tire pressure monitoring system
- Auto anti-dazzle rearview mirror
- 360 panoramic visual driving assist

>> best passive safety among peers

- 2510mm longest side cushion among peers
- All rounded six airbags
- Strongest thermoforming pillar among peers
- 5000mm longest roof laser welding
- More than 70% strong and ultra-strong steel car body
- Chassis armor protection
- TCS Traction Control System
- EDC Engine Drag Control
- ISOFIX and Top-Tether





Intelligent Interconnection Providing an Information Superhighway

To communicate with outside world by intelligent internet while seating in the car becomes a popular demand from drivers and passengers. With a standard 12.3-inch high-definition touch screen, SAIC MAXUS D90 redefines the smart life. Using cubic design and HMI design conveying a sense of vertical layers, create a lively suspension effect full of technical sense.

The resolution ratio of 12.3-inch large screen can reach 1920*720. If they like, passengers can share their trip journals and use intelligent payments during the journey. HD screen brings about a disruptive visual experience;

SAIC MAXUS D90 uses 8-inch high-definition digital dashboard, furthermore, it possesses OTA air remote iterations. Online music and voice interaction can be chosen freely and give you a happy journey.

Intelligent Technology, Open the new world of driving fun

The moment you enter SAIC MAXUS D90,

You enter a futuristic world filled with intelligent futuristic technology.

Intelligent Start-Stop, one-button start ,

Not only energy saving

but also providing more drive selections.

Theater-level NVH mute effect,

Admire the external scenery while

enjoy the inner peace.

More hi-tech equipment,

Let you guide the future and

Walk with safety and comfort.



>> Intelligent Start-Stop

Engine intelligent start-stop can minimize the fuel loss under idling conditions, avoiding energy waste and having a great meaning for energy conservation and emission reduction.



>> One-button start

Carry about the key and you can press the button to unlock car doors without taking out the key. Move shifter to P, step on the brake and hold for 3s, then you can start and stop the engine in a convenient way.



>> Induction electric tail door

The tail door is easy to open with four methods: key, reading light switch, Touchpad and Kick sensor. It has an intelligent anti-clamp function. If the tail door encounters obstacles during its opening and closing, a reversal stop can effectively avoid clamp. Garage mode can adjust the height of the tail door. Long press the interior panel close button in ideal height, release the button after the beep, then the tail door opens its memory mode.



>> Theater-level NVH mute effect

Body design with systematic noise reduction, active noise cancelling system and thick passive acoustic insulation package, give you the tranquil experience of Xanadu.



>> Seat functions: power ventilation, heating, massage and memory

Car seats have such functions as ventilation, heating, massage and memory which can provide you and your family a comfortable and pleasant ride feeling.

Live freely

Let desire and passion come into a state of balance and live freely

Freedom, is endless thirst for ultimate driving pleasure;
Freedom, is stretching your body comfortably, enjoying
the ups and downs, and from now on embracing the world.
Freedom, is enthusiasm to leave behind the distant landscape.
From no compromise in heart to an open-ended,
Let desire and passion come into a state of balance and live freely.



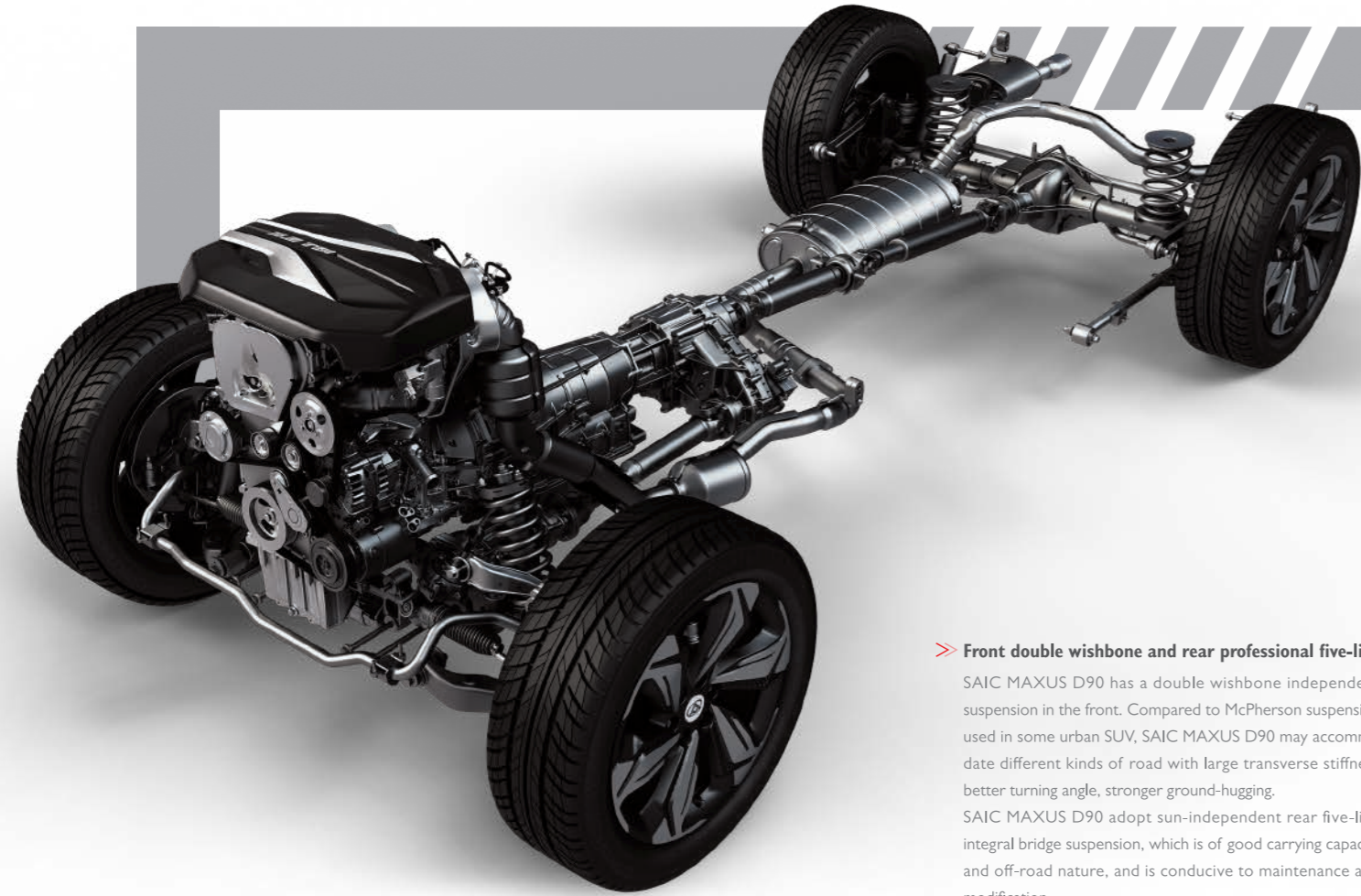

» **Front double wishbone and rear professional five-link suspension**

SAIC MAXUS D90 has a double wishbone independent suspension in the front. Compared to McPherson suspension used in some urban SUV, SAIC MAXUS D90 may accommodate different kinds of road with large transverse stiffness, better turning angle, stronger ground-hugging. SAIC MAXUS D90 adopt sun-independent rear five-link integral bridge suspension, which is of good carrying capacity and off-road nature, and is conducive to maintenance and modification.



» **Seven driving modes for all terrains**

Auto mode
ECO mode
SNOW mode
SAND mode
MUD mode
ROCK mode
SPORT mode



» **Power controlled mechanical differential locks**

When a skid occurs on one side of the rear wheel, the mechanical differential locks can provide rigid connection between two half shafts of the rear wheel and integrates them. So that both sides of the wheel can have same momentum to help the vehicle get out of trouble more quickly.



**Even with rocky tracks and roads,
you can still enjoy a smooth journey**

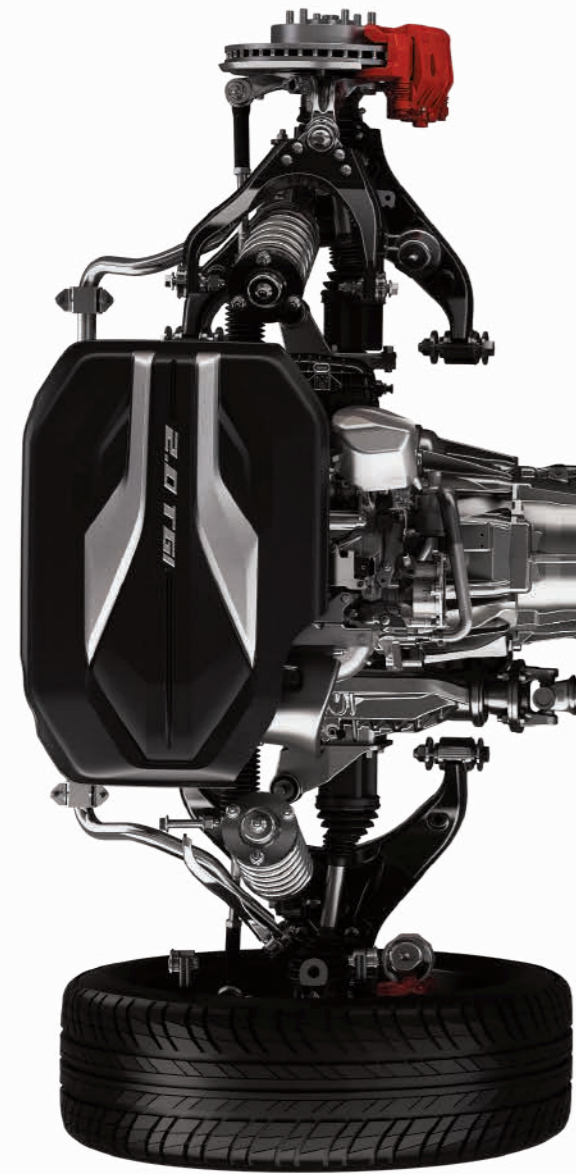

>> **Luxury-class steering performance**

Adopt belt-driven R-EPS electric steering mechanism, equipped with more compact new generation brushless motor and ECU integrated unit EPP; Maximum rack force may attain 12KN, equipped with ball-screw structure which has better transfer efficiency, transmission friction and stiffness compared to turbine worm structure, more easily to ensure the low friction and accuracy of steering and can achieve luxury-class steering performance.

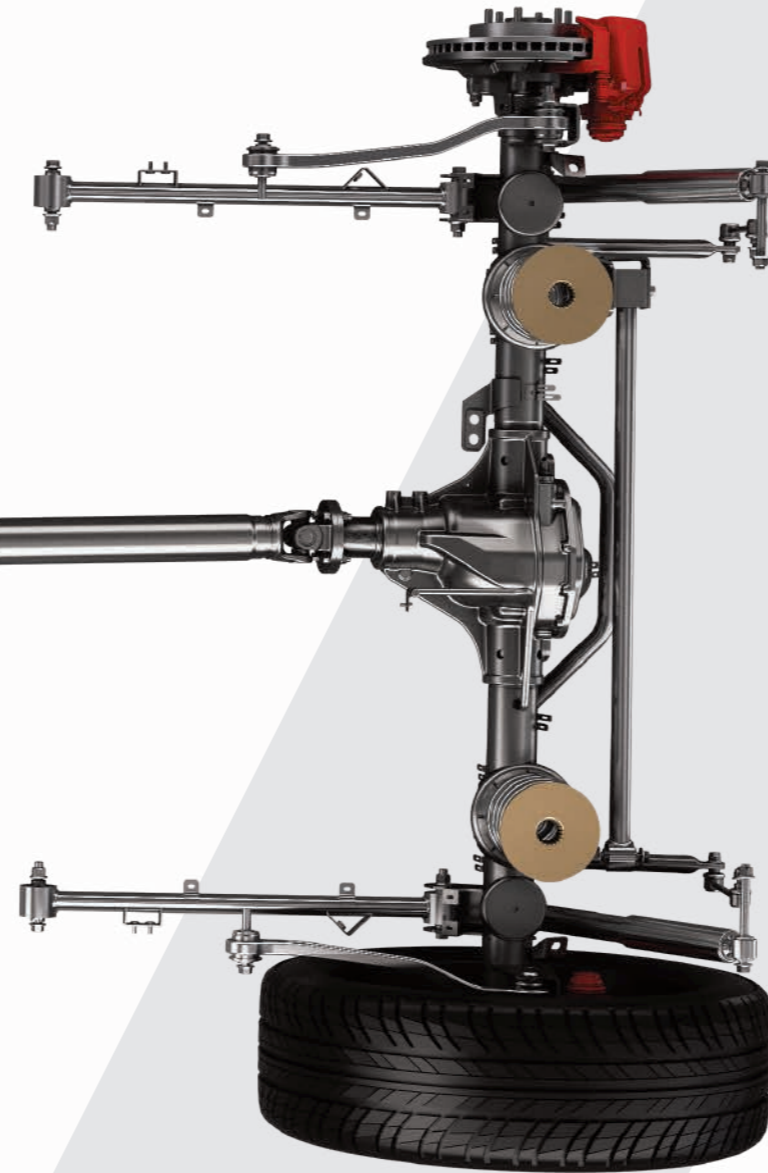

Global First: two kinds of four-wheel drive mode for your choice

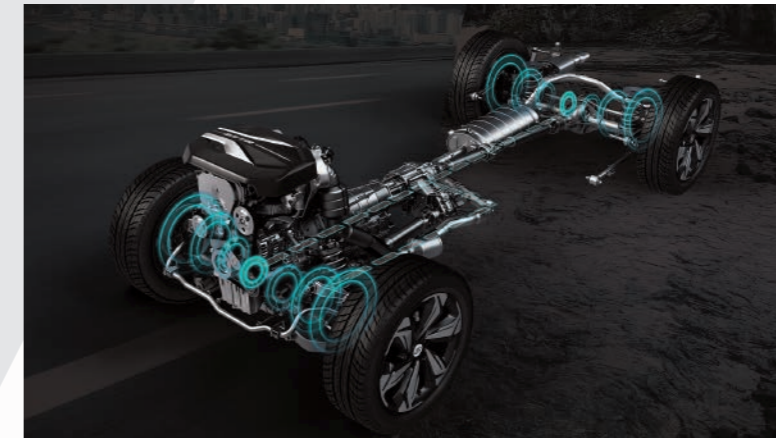

>> **All-terrain intelligent real-time four-wheel drive**
Seven types of driving mode to achieve full road coverage and to meet the driving needs of different users.



>> **Professional part-time four-wheel drive (4WD)**
Three kinds of driving mode which can be set to 2H/4H/4L, satisfying different driving demands and suitable for professional off-road players.

2.0T Direct-injection turbocharged gasoline engine with high-performance

> SAIC Motor NLE-New-Large-Engine series specially strengthen and adjust performance for SAIC MAXUS D90 with the peak torque up to 360N·m and the maximum horsepower up to 224ps; Automatic vehicles provide multiple driving modes like ECO, Normal and Sport. Sport mode can provide more active power response; The engine is equipped with many electronic auxiliary equipment, which effectively improves efficiency and reduces energy consumption.

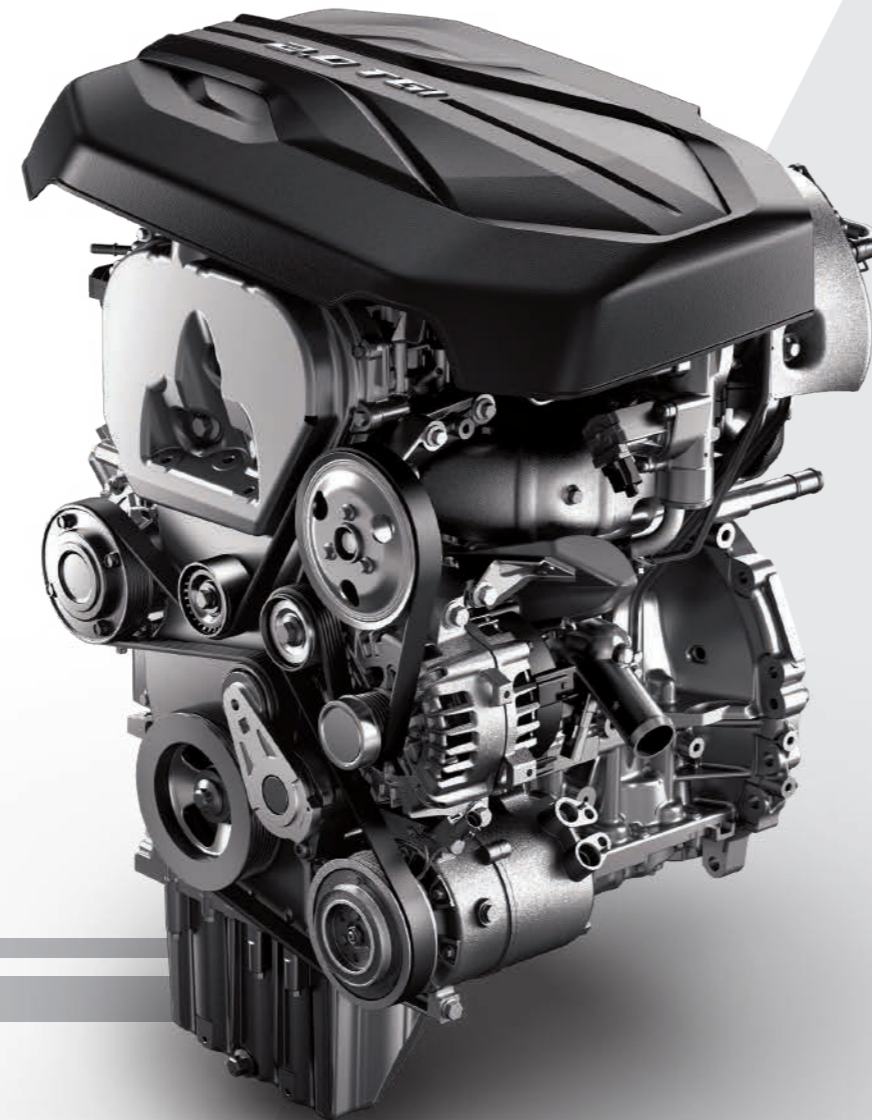

If filled with emotion, then why fear constant changes?

•EPS Electronic power steering

Replace traditional HPS hydraulic power steering and average energy consumption can be reduced by 80%.

•Electronic Pump

Better control over flow of engine coolant.

•Electronic Thermostat

Compared with paraffin-thermostat, electronic thermostat can control the flow of coolant more accurately and improve the efficiency of engine.

•Variable displacement air compressor

Effectively reduce the system energy consumption caused by high fluctuation of air-conditioning's temperature and system's frequent switch. In addition, it can effectively reduce the distracting for automo-

bile engine caused by the periodic clutch of the compressor.

•0.35 ultra low drag coefficient among peers

On the basis of large body size, the drag coefficient can be less than 0.35 after careful design. Aerodynamic details: hollow design in front fog light area, hollow process in rear parts of front wing, tail design, flat air filter design, low rolling resistance tires, Continental tires.

•Accelerate speed from 0-100km/h in 9.8s

Because of its stronger output power and broad output range of maximum torque, high-performance turbocharged engine can equip the vehicle with maximum acceleration capability at very low rotational speed.



Live spaciously

From limitation to infinity, to live spaciously.

Space is innovation, mood and pattern,
Greater space brings family closer together.
Let strange hearts collide,
Sagacity grows into a vision;
From family trip, business travel to finding a new
world alone,
From limitation to infinity, to live spaciously.



>> **Real full-size SUV (mm)**

Length 5005
 Width 1932
 Height 1875
 Ultralong wheelbase 2950

>> **Distinguished interior space (mm)**

First row head room 1025
 First row shoulder room 1530
 Second row head room 1005
 Second row shoulder room 1532
 Second row maximum moving distance 1122

>> **Three separate seats of theatre-style in third row. (mm)**

Third row head room 955
 Third row shoulder room 1425
 Third row maximum longitudinal knee space 960



>> **Trans-Beyond airline business class seats available for lying flat.**

In "1+2" and "1+2+2" seat layout, the seats can span longitudinally across the space of the first and second rows, liberating more room for front passenger seat, providing passengers with ultimate comfort and space, improving luxury experience. Furthermore, there are eight kinds of flexible seat layout from 3 to 8 seats for your choice.



>> **Huge luggage space**

The second and third rows can be completely laid flat, forming a 2.3m*1.5m space; large trunk space of 350L-2390L.



>> **User-friendly storage space**

SAIC MAXUS D90 provides rich and convenient user-friendly facilities with 35 storage spaces, gives special care to each passenger with biggest convenience and comfort.

The space is tangible but the pattern is invisible.

User-friendly facilities make comfort easier



>> Air Clean System

Monitor the PM2.5 concentration in car at all times and can filter PM2.5 particulate matter, keep the air fresh and provide comfortable and healthy ride environment.



>> Universal Panoramic Sunroof

Lighting area reaches 1.14 square meters, openable area reaches 0.53 square meters; Sunroof control module is provided by "Bosch" and has damp-proof function; Electric window shades with 100% sun-shading are made from German imported fabric.

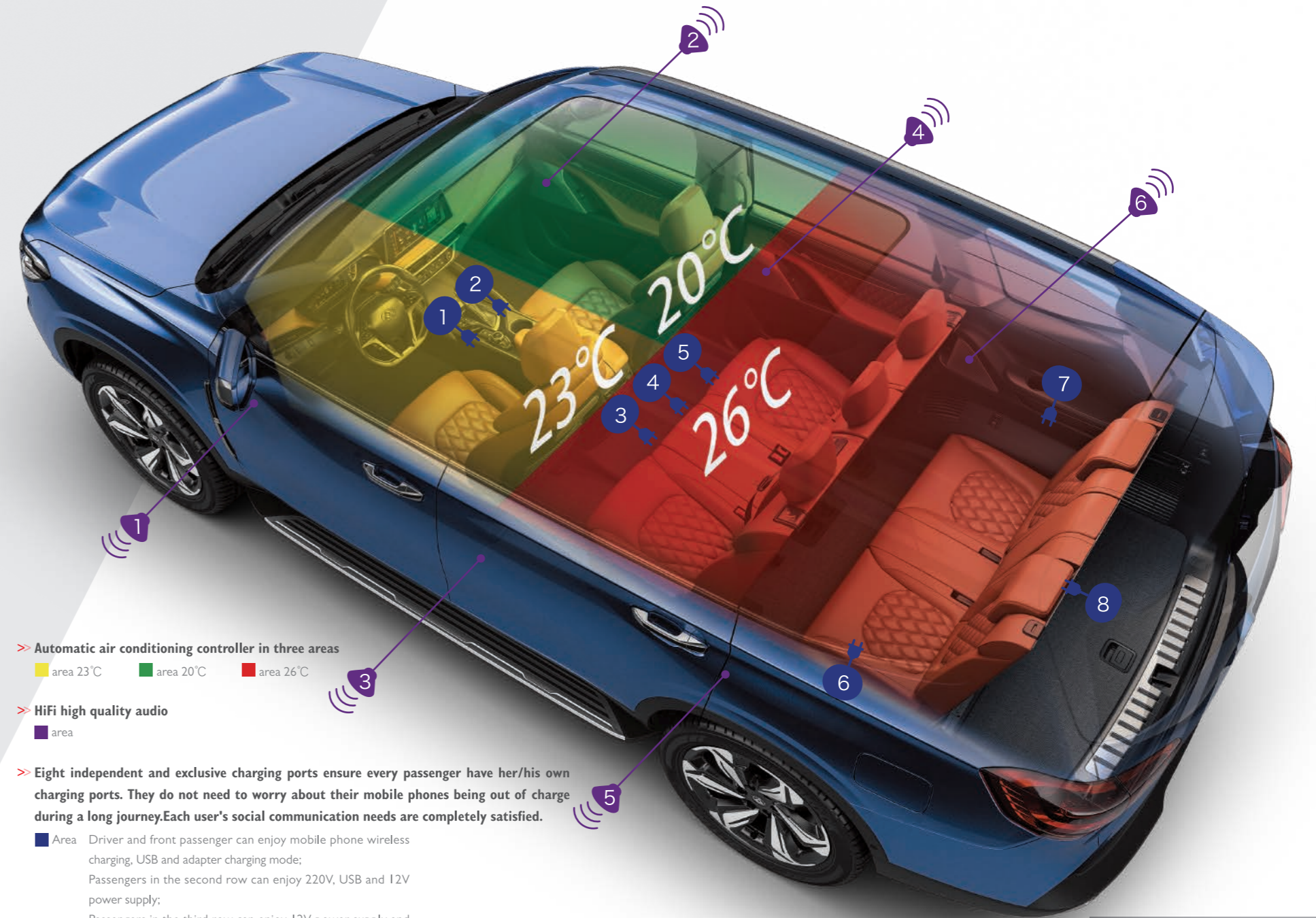

>> Automatic air conditioning controller in three areas

■ area 23°C ■ area 20°C ■ area 26°C

>> HiFi high quality audio

■ area

>> Eight independent and exclusive charging ports ensure every passenger have her/his own charging ports. They do not need to worry about their mobile phones being out of charge during a long journey. Each user's social communication needs are completely satisfied.

■ Area Driver and front passenger can enjoy mobile phone wireless charging, USB and adapter charging mode;
 Passengers in the second row can enjoy 220V, USB and 12V power supply;
 Passengers in the third row can enjoy 12V power supply and USB charging mode

Live uniquely

Live like along-lost self, live uniquely

Abandon the sameness of replication,
realize unique inspiration,
Let dozens of customization options,
Give me, and us distinctive personalities;
Give you a car that really belongs to you,
Live like a long-lost self, live uniquely.



Full-scale customization, creates a “car of yours”

SAIC MAXUS intelligent car-purchase platform-"I can buy a car"

Provides 3D car models, multimode for choosing a car, fast order placing

Online consultation and transparent digital factory

One-stop interactive experience tracked online through all processes.

Allows each user to customize the core features and configurations.

Full range of configuration options

Fulfill all your fantasies about the ideal SUV in your heart.

Choose your

Basic equipment

Optional configurations:

gearbox, driving mode, differential locks,

seat layout

Choose your

Innovative exterior

Optional configurations:

Exterior color, wheel hub and tyre, radiator

grille, body decoration trim set, wheel trim,

personalized micro-logo, body decoration

mask, front and rear headlamps, decorative

color of front headlamps, surface color of

rear taillights, sunroof, lower decoration plate

of front bumper, tailpipe, rear privacy glass,

brake caliper color

Choose your

Ingenuity Interior

Optional configurations:

Seat cover fabric, seat fabric pattern,

interior style, instrument panel,

Auxiliary instrument table handle,

welcome pedal, Shift lever, trunk net bag

Choose your

Safe control

Optional configurations:

Chassis protection plate, side airbag curtain,

tire pressure monitoring system, parking brake,

rear view camera, blind zone monitoring system

Choose your

Technology interconnection

Optional configurations:

Moodlighting, Automatic parking auxiliary system, instrument screen type,

ADAS intelligent auxiliary automatic driving system,

loudspeaker, wireless charging device for mobile phone, air purifier

Choose your

Comfort and convenience

Optional configurations:

Car key color, PEPS (Passive Entry Passive Start),

Air conditioning system, down-corner lamp, driver seat,

front passenger seat, second row seats, external rearview mirror,

inner rearview mirror, Rear door opening mode, key,

steering wheel, steering wheel heating

Exterior color



>> Sapphire Blue



>> Zircon Red



>> Blanc White



>> Obsidian Black



>> Lava Grey



>> Olive green



>> Aurora Silver



>> Amber Gold



>> Support Personalized Customization

Interior style



>> Beige interior



>> Brown interior



>> Black interior



>> High-end leather & cloth mixed seat



>> High-end leather seat

Seat fabric

Dashboard panel



>> cladded by beige leather



>> cladded by brown leather



>> cladded by black leather

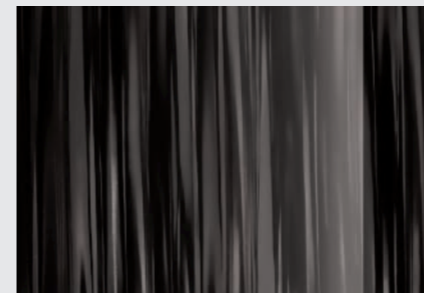

>> Dyna-wave

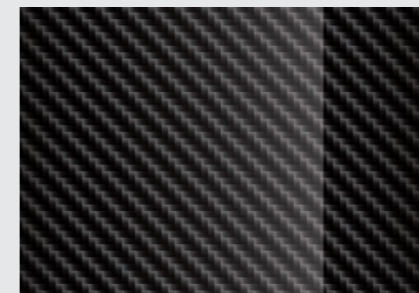

>> carbon fiber

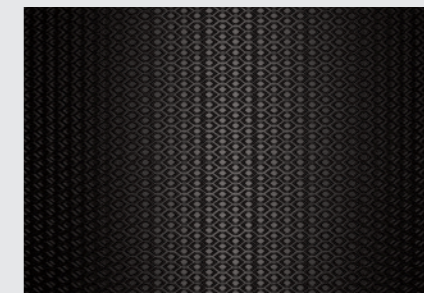

>> high-tech honeycomb

Specification

	Model	RWD with MT		RWD with AT		4WD with MT	4WD with AT		
		Mars(Basic)	Mars	Mercury	Uranus	Neptune	Sirius	Polaris	Full
Basic Parameter	Length/Width/Height(mm)	5005/1932/1875							
	Wheelbase (mm)	2950							
Engine	Fuel Type / Displacement	Petrol/2.0T							
	Emission Standard	State V							
	Maximum Power(kW)	165							
	Max. Torque (Nm)	360							
Transmission	Transmission Type	6MT		6AT+Start-stop Engine		6MT	6AT+Start-stop Engine		
Drive Type	Drive Type	RWD				Real-time 4WD	Real-time 4WD for all-terrains ●/Part-time 4WD ○		
Chassis	Suspension Type (Front/Rear)	Dual Helix Independent Suspension/ The five-link integral suspension+ Stabilizer bar							
	2+2+3	○	●	●	●	●	●	●	●
	2+2+2	○	○	○	○	○	○	○	○
	2+3+2	○	○	○	○	○	○	○	○
	2+3+3	○	○	○	○	○	○	○	○
	2+3	●	○	○	○	○	○	○	○
	2+2	○	○	○	○	○	○	○	○
	1+2	-	-	-	○	-	○	○	○
Seat Layout	1+2+2	-	-	-	○	-	○	○	○
	255/65/R17 AT	○	○	○	○	○	○	○	○
	255/60/R18 HT	●	○	○	○	○	○	○	○
	255/55/R19 HT	○	●	●	●	●	●	○	○
	265/45/R21 HT	○	○	○	○	○	○	●	●
Tyre Type	Front Airbag	●	●	●	●	●	●	●	●
	Front Side Airbag	●	●	●	●	●	●	●	●
	One-piece Side Airbag Curtain for Three Rows	-	-	-	●	-	●	●	●
	TPMS	○	●	●	●	●	●	●	●
	ISOFIX	●	●	●	●	●	●	●	●

Specification

	Model	RWD with MT		RWD with AT		4WD with MT	4WD with AT		
		Mars(Basic)	Mars	Mercury	Uranus	Neptune	Sirius	Polaris	Full
Safety and Security	ESP (Including RMI, HHC, HBA etc.)	●	●	●	●	●	●	●	●
	HDC(Hill Descent Control)	●	●	●	●	●	●	●	●
	Rear Axle Electromechanical Differential Lock	-	-	-	-	-	○	●	●
	Front Parking Sensor	●	●	●	●	●	●	●	●
	Rear Parking Sensor	●	●	●	●	●	●	●	●
	Reverse Camera	●	●	●	-	●	-	-	-
	360 ° Panoramic Visual Driving Assistant System	○	○	○	●	○	●	●	●
	ADAS(including ACC, LDW, AEB)	-	-	-	○	-	○	●	●
	BSD(Blind-spot Detection)	-	-	-	○	-	○	●	●
	Comfort and Convenience	EPS (Electronic Power Steering)	●	●	●	●	●	●	●
EPB+Auto-Hold		-	-	-	●	-	●	●	●
Mechanical Brake		●	●	●	-	●	-	-	-
APA(Auto Parking Assistance System)		-	-	-	-	-	-	●	●
PEPS Remote Keyless Entry + One-button Start		-	-	●	●	-	●	●	●
Cruise Control		●	●	●	●	●	●	-	-
Power Tail gate		○	○	○	●	○	●	●	●
Easy Open Tail gate		-	-	-	●	-	●	●	●
Air-condition System		Manual		Auto		Manual	Auto		
All Power Window + One-button Power Window for Driver		●	●	●	●	●	●	●	●
Rain-Sensing Wiper	-	●	●	●	●	●	●	●	
Diamond Leather Seat Fabric	○	○	○	○	○	○	●	○	
Leather Seat Fabric	○	○	○	●	○	●	-	-	
High-end Leather & Cloth Mixed Seat Fabric	●	●	●	-	●	-	-	-	

Specification

Model	RWD with MT		RWD with AT		4WD with MT	4WD with AT			
	Mars(Basic)	Mars	Mercury	Uranus	Neptune	Sirius	Polaris	Full	
Comfort and Convenience	Electrically Adjust Drivers Seat with 8 Ways + Power Lumbar Support with 4 Ways	-	-	●	-	●	●	●	
	Driver Seat with Ventilation + Massage + Memory Function	-	-	○	-	○	●	●	
	Manually Adjust Seat With 6 Ways for Driver	●	●	●	-	●	-	-	
	Electrically Adjust Seat with 4 Ways + Power Lumbar Support with 4 Ways +Power Heating for Front Passenger	-	-	-	-	-	○	●	●
	Manually Adjust Seat with 4 Ways for Front Passenger	●	●	●	●	●	●	-	
	Power Heating Seat for 2nd Row	-	-	-	-	-	-	●	●
	Easy-Entry into 3rd Row from Two Sides	●	●	●	●	●	●	●	●
	Multifunction Steering Wheel +Manual Adjustable Function with 4 Ways	PU/Leather Optional		Leather	PU/Leather Optional	Leather			
	Heating Steering Wheel	○	○	○	○	○	○	○	●
	Baggage Clapboard (Can be Stored in Trunk)	●	●	●	●	●	●	●	●
Technology and Entertainment	Driving Computer Screen	4.2 Inch		8 Inch	4.2 Inch	8 Inch			
	Remotely Start Engine Function	-	-	○	●	-	●	●	●
	Multimedia Entertainment System	●	●	●	○	●	○	-	-
	Smart High-Resolution Touch Screen (12.3")	●	●	●	●	●	●	●	●
	Mobile Mapping	●	●	●	●	●	●	●	●
	Air Clean System	-	-	-	○	-	○	○	●
	Bluetooth	●	●	●	●	●	●	●	●
	Power supply	●	●	●	●	●	●	●	●
	220V Power Supply	○	○	○	●	○	●	●	●
	Wireless Charging for Mobile Phone	○	○	○	○	○	○	●	●
Audio System	High-Quality Audio System With 6 Speakers		Hi-Fi Stereo Surround Audio System with 12 Speakers	High-Quality Audio System With 6 Speakers	Hi-Fi Stereo Surround Audio System with 12 Speakers				

Specification

Model	RWD with MT		RWD with AT		4WD with MT	4WD with AT		
	Mars(Basic)	Mars	Mercury	Uranus	Neptune	Sirius	Polaris	Full
Adaptive LED Headlight + LED Taillight	○	●	●	●	●	●	●	●
Halogen Lens Headlight + Halogen Taillight	●	-	-	-	-	-	-	-
LED Daytime Running Light	●	●	●	●	●	●	●	●
Front Foglight +Steering Assistant	●	●	●	●	●	●	●	●
Power Single-Piece Skylight	○	●	●	●	●	●	-	-
Universal Panoramic Skylight	○	○	○	○	○	○	●	●
Front Grille	● Chromium Plating Three-grates Net Grille with MAXUS Logo /o Bright Black Three-grates Net Grille with MAXUS Logo /o Star-Type Inlet Grille with MAXUS Logo /o Mesh-Type Inlet Grille with MAXUS Logo /o Mesh-Type Inlet Grille with MAXUS Logo							
Baggage Holder	Painting Baggage Holder		Chromium Plating Baggage Holder	Painting Baggage Holder	Chromium Plating Baggage Holder			
Side Step	Painting Side Step		Chromium Plating Side Step	Painting Side Step	Chromium Plating Side Step			
Tail Pipe	Hidden Double Tail Pipe		Square Double Tail Pipe	Hidden Double Tail Pipe	Square Double Tail Pipe		Four Sport Tail Pipe on Bilateral Sides	
Privacy Glass for Rear Row	○	●	●	●	●	●	●	●
Power Rearview Mirror with Heater	●	●	●	●	●	●	●	●
Power Folded Rearview Mirror	○	●	●	●	●	●	●	●
Outer Rearview Mirror Light	-	-	-	●	-	●	●	●
Inside Atmosphere Lamp with 64 colors	○	○	○	○	○	○	●	●
Inner Anti-glare Rearview Mirror	Manual / Auto					Auto		
Welcome Pedal	Chromium Plating					Chromium Plating With LED Backlight		
Cross-country Fender, Special Logo, Off-road Wheel Eyebrow, Headlamp Color, Blackened Taillight, Spray Color Caliper, Secondary Instrument Handle, Plating Chassis Armor Plate, Trunk String Bag, Front and Rear Fenders, Secondary Instrument Handle, Body sticker, Foot Pad	○	○	○	○	○	○	○	●

* D91 has no fixed version, except basic and full version, the other listed versions are mainly defined by many users at present.
 *The standard for Part-time 4WD is rear wheel automated mechanical differential lock*SAIC MAXUS D91 has more optional configurations.
 IP-customized version is available. Please subscribe our WeChat account "our Maxus" to customize your favorite car.
 Remark : "●" For Available , "-" For No, "○" For Optional .The specific configurations and parameters are subject to real vehicles, SAIC MAXUS reserves the rights of final interpretation and modification.

The visible glory comes from invisible hard power

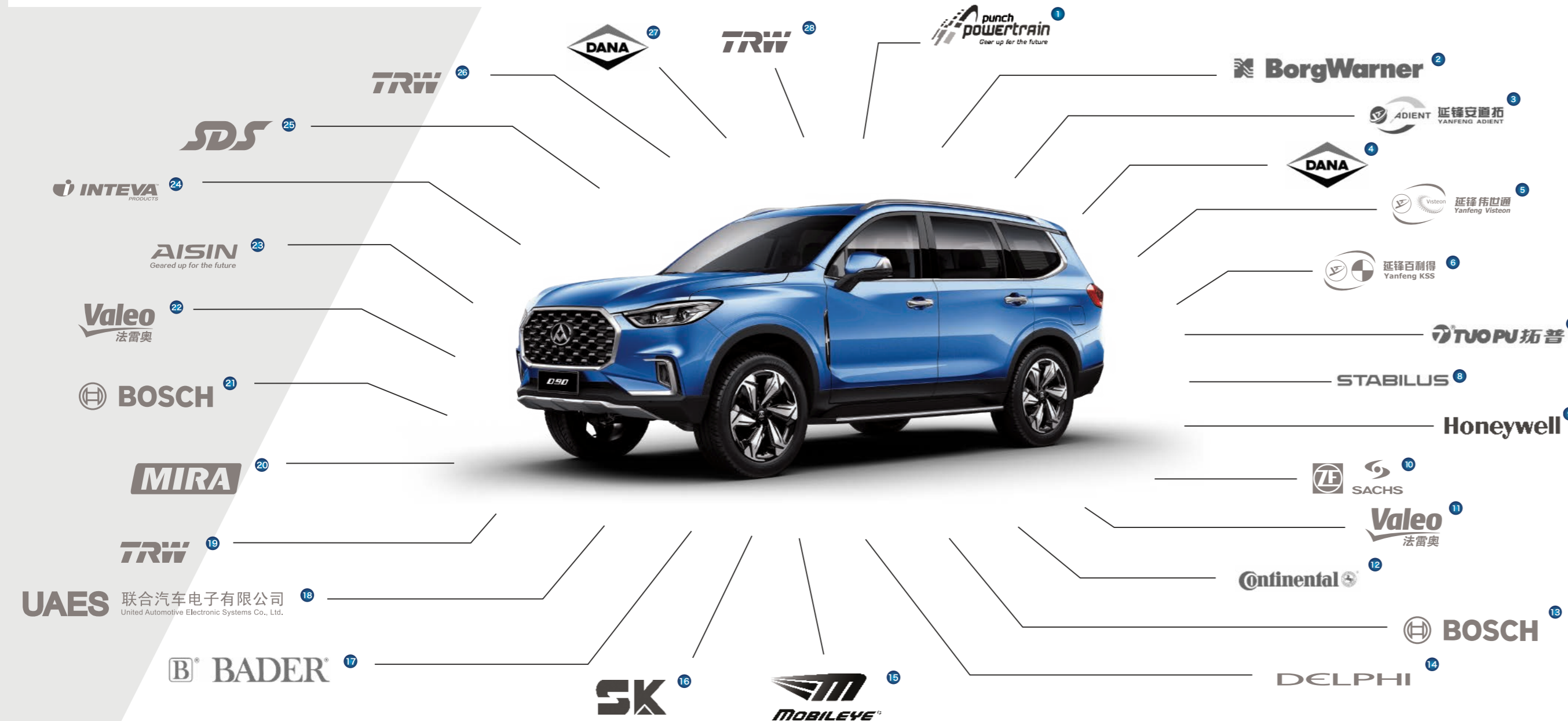

As one of the world's top 500 enterprises and the largest Chinese automaker, SAIC Motor seek strategic cooperation with world-renowned auto parts enterprises; SAIC MAXUS D90 relies on global superior resources and all the key parts are provided by internationally recognized auto parts suppliers with reliable quality and outstanding performance.

- | | | |
|--|---|---|
| <p>1 Gearbox
Punch Powertrain (France)
BMW, Cadillac</p> <p>4 Power controlled mechanical differential locks
Dana
Ford, BMW</p> <p>7 Carpet
TUOPU
Cadillac, Volkswagen</p> <p>10 Damper
Sachs
Mercedes Benz, BMW</p> <p>13 Airbag Controller
Bosch
Mercedes Benz, BMW</p> <p>16 LED Front Headlamps
SK
General Motors, Volkswagen, Ford</p> <p>19 Steering system
TRW
General Motors, Ford</p> <p>22 Dual-mass flywheel
Valeo
General Motors, Volkswagen</p> <p>25 Drive Shaft
SDS
Mercedes Benz, BMW</p> <p>28 EPB Electronic Hand brake
TRW
General Motors, Ford</p> | <p>2 All-wheel-drive system
BorgWarner
BMW, Audi</p> <p>5 Instrument panel
Yan Feng
BMW, General Motors, Ford</p> <p>8 Tail door pneumatic rod
Stabilus
Mercedes-Benz, Volkswagen</p> <p>11 Generator-Starter
Valeo
General Motors, Volkswagen</p> <p>14 Wiring Harness
Delphi
General Motors, Volkswagen</p> <p>17 Leather Fabric
Bader
General Motors</p> <p>20 Chassis set-up
Mira
Ferrari</p> <p>23 Single Skylight
Aisin
General Motors, Toyota</p> <p>26 Braking system
TRW
General Motors, Ford</p> | <p>3 Seat
Yanfeng Adient
BMW, General Motors, Ford</p> <p>6 Airbag
Yanfeng KSS
General Motors, Volkswagen</p> <p>9 Turbocharger
Honeywell
General Motors, Ford</p> <p>12 Tire
Continental
Mercedes Benz, BMW</p> <p>15 ADAS Active Security System
Mobileye (Israel)
Tesla, General Motors, Volkswagen</p> <p>18 BCM
UAES
BMW, General Motors, Volkswagen</p> <p>21 ESP
Bosch
Mercedes Benz, BMW</p> <p>24 Panoramic Skylight
Inteva
Volkswagen</p> <p>27 Rear Axle
Dana
Ford, BMW</p> |
|--|---|---|